

# SKYFIRE CNC

## AUTO TOOL CHANGER

### DATASHEET

#### ATC-BT30-12T

Model: ATC-BT30-12T

Max Tool Capacity: 12  
 Max Tool Weight: 4.0kg  
 Cylinder Stroke: 200mm  
 Tool chain Division Time:  
 0.6s/50Hz(0.5sec/60Hz)  
 Control Element: Active LOW  
 Control IO Voltage: 12VDC/24VDC optional  
 Power Voltage: 220VAC/120VAC optional

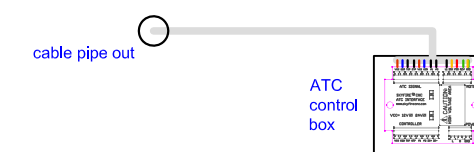
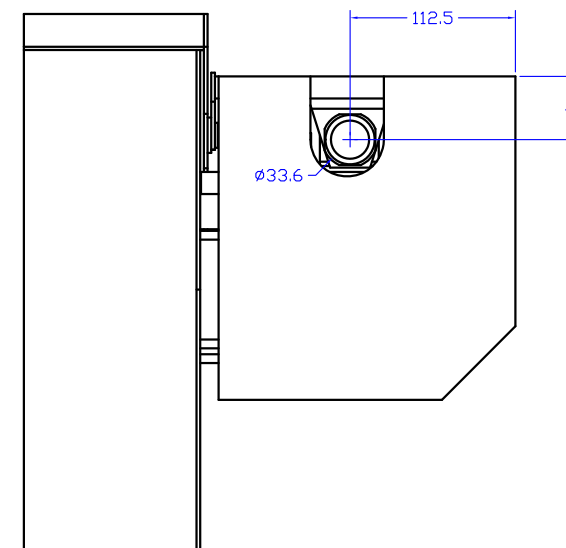
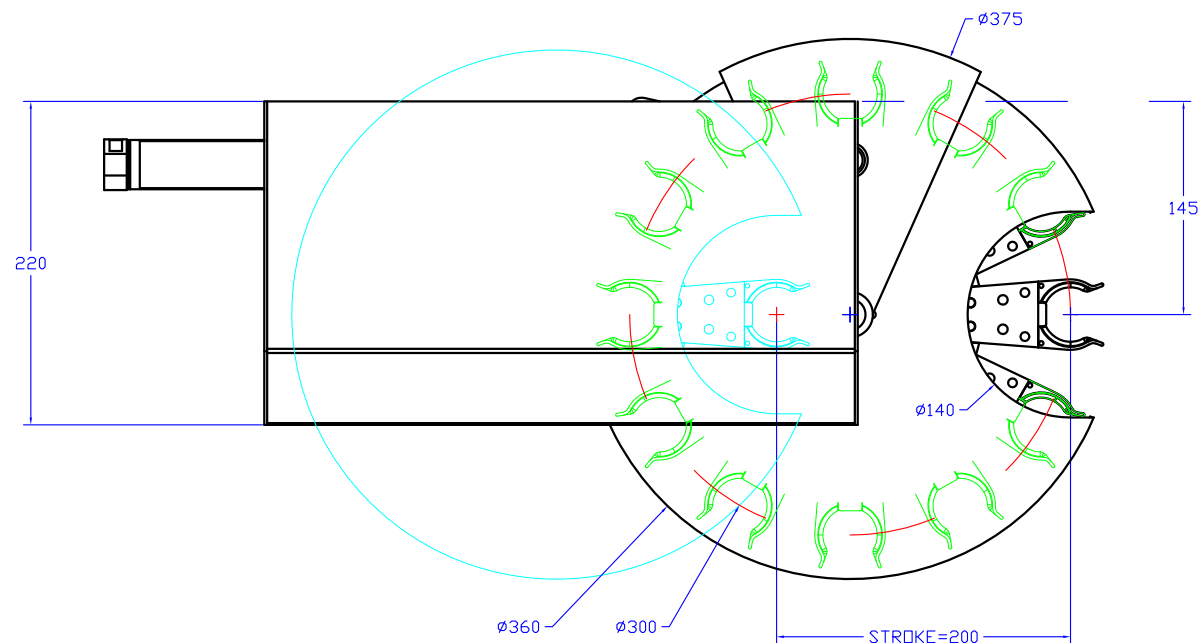
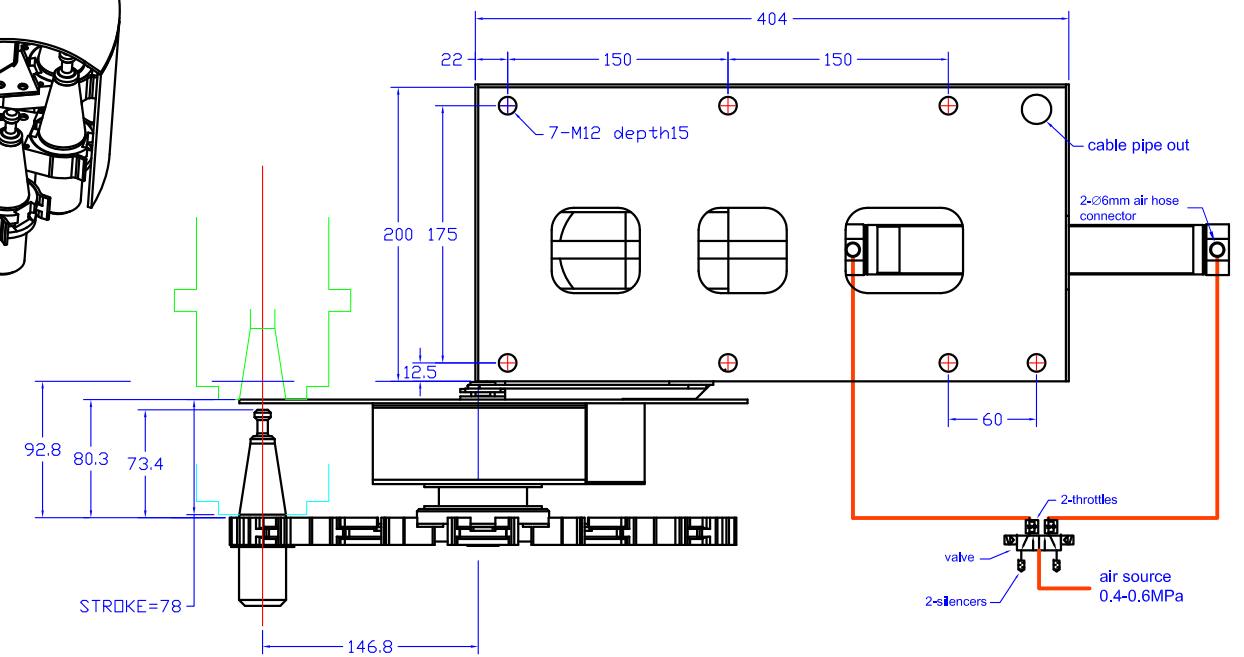
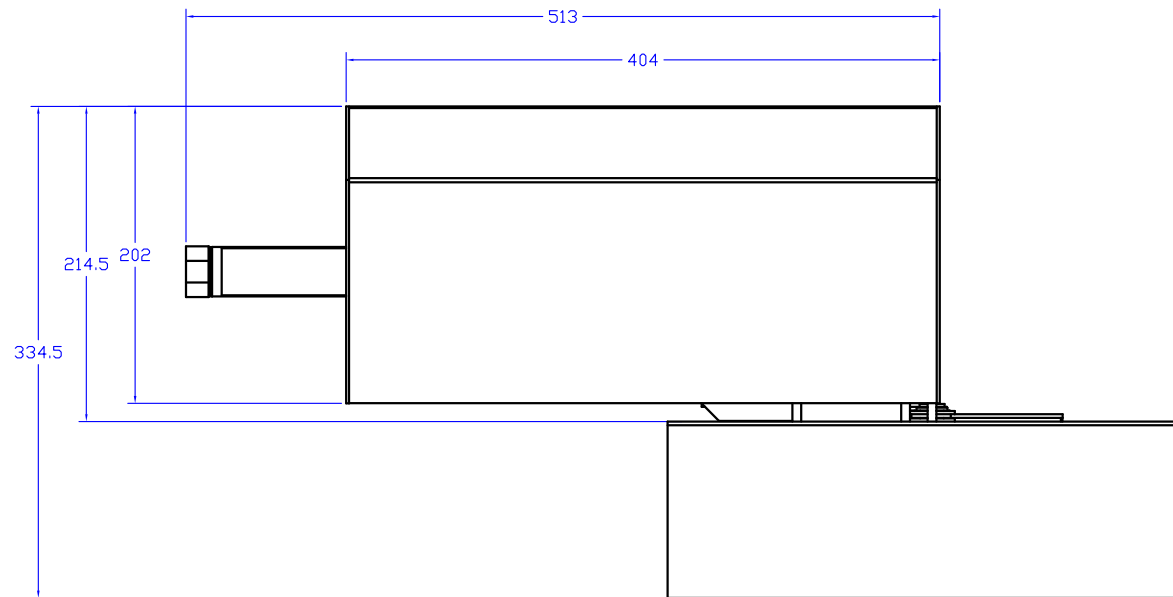
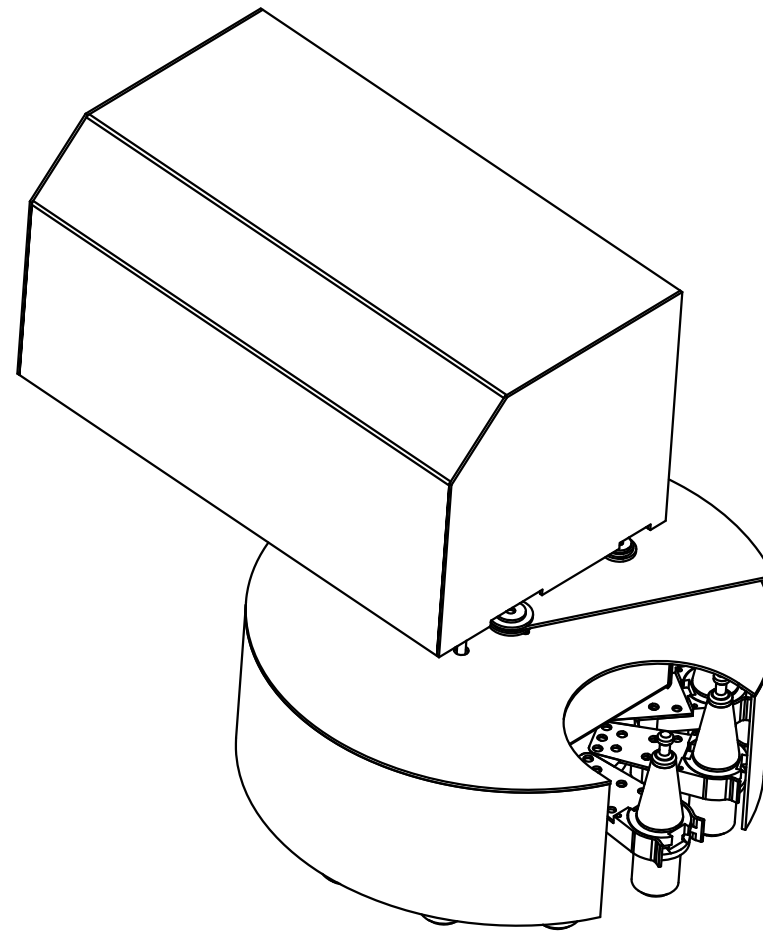

VCC: +12V or +24VDC (depend on the PCB mark)  
 COM: 0VDC  
 TCP: tool changing position signal out (NPN output)  
 STP: standby position signal out (NPN output)  
 P1: tool counting signal out (NPN output)  
 P2: NC (optional TOOL1 HOME signal out)  
 DR+: carousel rotate CW signal in (active LOW)  
 DR-: carousel rotate CCW signal in (active LOW)

L: power phase line (220VAC 50/60Hz, other voltage please contact us)  
 N: power null line  
 GND: connect to earth